

# TGR85 THERMOSTAT USER GUIDE



This thermostat is suitable for water heating, electric heating and boiler

# Welcome

Thank you for your trust and support!

We have adopted advanced technology and perfect craftsmanship so that your new thermostat will provide you with a suitable temperature environment every day in the future.

## Main Functions and Characteristics

1. WIFI for Android & Apple iOS
2. Large screen display and touch button
3. Power-off memory function
4. Real-time data save function
5. 5+2 or 6+1 or 7 days six periods program schedule
6. Anti-freezing function
7. 3 sensor modes can be setting
8. With child lock function

## Product Packaging

Model	TGR85-EP	TGR85-WP	TGR85-WPB
Thermostat	✓	✓	✓
User Manual	✓	✓	✓
Screws *2	✓	✓	✓
External sensor	✓		

## Model Spec

Model	Current Loading	Week Program	Controlled Objects
TGR85-EP	16A	✓	For electric heating appliances
TGR85-WP	3A	✓	For water heating appliances
TGR85-WPB	3A	✓	For boilers connected via dry contact

## Technical Parameter:

Power Supply	100 ~ 240V
Current Load	≤3A (water heating/gas boiler) ≤16A(electric heating)
Power Consumption	<1W
External Material	PC+ABS (flame retardant)
Sensing Element	NTC
Set Temp. Range	5-95°C
Floor Set Temp. Range	5-60°C
Temperature hysteresis	±1°C (Defaults adjustable 0.5-10°C)
Dimension	86x90x14mm
Ambient Temp.	0-45°C,5-95%RH(Non-condensing)
Storage Temp.	-5~55°C
Timing Error	<1%

# User Notes

1. Please read this manual carefully. Improper operation may damage the product or cause dangerous conditions.
2. The installation personnel must be well-trained and experienced service technicians.
3. After installation, please read this manual carefully and operate the product according to the instructions.

Caution: Risk of electric shock

# Wiring Diagram

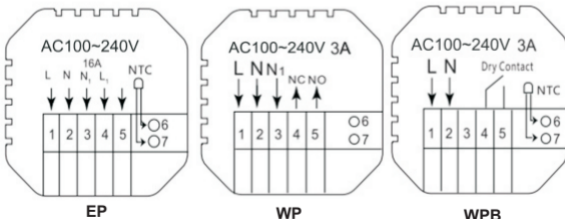

(External sensors cannot be connected)

# Installation Instruction

This product is suitable for standard **86\*86mm** wall box and **60 mm** european round box.

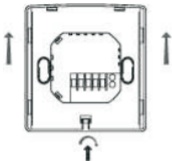

1. Turn the fixator so that the arrow is aligned with the display screen. Remove the mounting plate.



2. Remove the mounting plate in this direction.

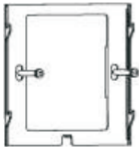

3. Fix the mounting plate on the cassette with a screw.

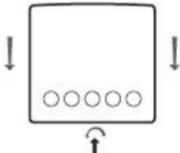

4. Insert the thermostat into the mounting plate from top to bottom and reuse the screwdriver to rotate the fixator 180 degrees to complete the installation.

# Description of display & icon

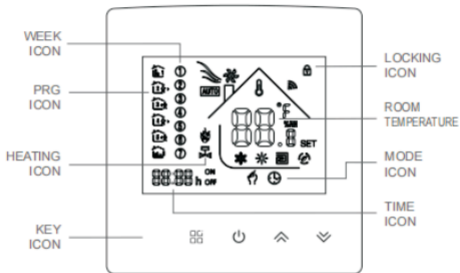

# Operation Instruction





## 1. Setting Power on/off

Press  to turn on/off the power.

## 2. Setting Temperature

Press   to set the temperature.

## 3. Setting the Clock

Long press  and  to set minute, Press   for adjusting.  
press  to set hour and week.

## 4. Switching modes

Press  key to switch between manual and programming mode  
Manual mode means non-programmable mode.

 display in the screen, it is in manual mode.

Press   to set the temperature.

 display in the screen, it is in programming mode.

## 5. Setting the Child Lock

Long press   to add child lock,  will display.

Long press   again, the child lock will be cancelled.

## 6. Setting the Programmable Mode.

Press and hold  into programming mode setting. 12345 and time will display.

12345 display in the position of week means 5+2;





Press   to change the time.

Press  to do the temperature adjustment.









Press   to change the temperature;

Press  to do the next period adjustment.

Press  to exit and save.

If you want to make temporary adjustment in any period, press  or , then   will display. It will run according to your manual settings and resume programming mode at the next programming time point

Press  to switch between manual mode and programming mode.



Period		Period Icon	Defaulted Time	Defaulted Temp.
Working day	1		6:00	20°C
	2		8:00	16°C
	3		11:30	16°C
	4		12:30	16°C
	5		17:30	22°C
	6		22:00	16°C
Rest day	1		8:00	22°C
	2		23:00	16°C





**Remark:**

1.The defaulted temperature of period3 and period4 is the same as period2. Please change it according to the request.



2.Do not set the last time point of each day beyond 23:59

## 7. Advanced Setting

In the state of **power-off**,press the  key and the  key for 5 seconds to enter the advanced option setting.

Press  to enter the next option, press  and  to adjust, and press  to save and exit.

Display Code	Function	Setting And Options	Factory Defaults
01	Temperature calibration	-9.9-9.9°C	-1.5°C
02	Sensor selection	IN:Use the internal sensor OUT:Use the external sensor ALL: Use both internal and external sensors.	IN
03	Measured temperature extreme value Modification	35-60°C	60°C
04	Temperature hysteresis	0.5-10°C	1°C
05	Antifreeze function	OFF:Close anti-frozen ON:Open anti-frozen	OFF
06	Weekly programming mode setting	7: 7 working days 6: 6 working day+1 rest day 5: 5 working day+2 rest day	5

07	Primary and secondary reverse selection	00:close the main and auxiliary reversal 01:auxiliary reversal	00
08	Backlight brightness	00 : turn off the backlight 01 : low brightness 02 : medium brightness 03 : high brightness	03
09	Set temperature upper limit	15-95°C	60
10	Sound	ON:turn on the sound OFF:turn off the sound	ON
11	Power outage memory function	00 : Thermostat switch status is the same as before power failure 01: Thermostat opens after power restoration 02: Thermostat closed after power restoration	00
12	Restore factory defaults	long press  button to adjust the display “---”,press  button to restore the factory settings	-

**Note:**08,10,11 only for wifi models

### Sensor error:

If no external sensor is connected, do not set it to **ALL** or **OUT**, otherwise **Er** will appear on the screen.And the thermostat will stop heating till the problem is solved.

If there is error of sensor **Er** will also appear on the screen.

# Phone Port Operation Instruction

## Preparation before Wi-Fi connection

APP download and account registration:

### 1.Download APP

For iOS system: Login in App Store, search “Tuya Smart”, you can download it on your iphone.

For Andriod system: Login in Google Play, search “ Tuya Smart” , you can download it on your phone.

Or scan below code to download:



## 2. Register Account

If you do not have an APP account yet, you can choose to register or log in via SMS verification code. Click “Create a new account”, you will enter the Tuya Smart Platform Privacy Policy page.

After you click Agree, you will officially enter the mobile phone registration page.

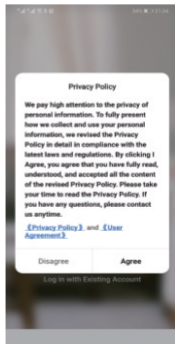
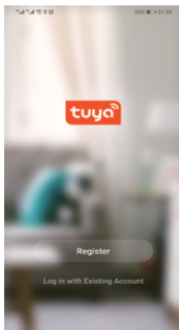

The system automatically determines the current country/region. You can also select the country/region manually. After entering your mobile phone number or email address, click “get verification code”. Enter the received verification code, then enter the password, and click “Finish” to register successfully.

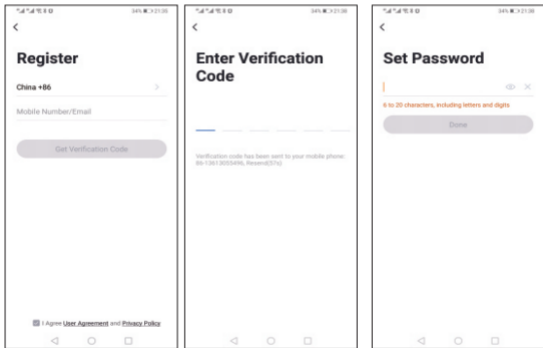

## WiFi connection

1. Turn on your mobile phone's Bluetooth and wifi  
(please make sure your mobile phone connect to **2.4Ghz Wi-Fi**).

2. Activate the thermostat WiFi module: When the thermostat is turned on, press and hold the  button for 5 seconds, the WiFi icon flashes on the thermostat display, and the thermostat enters the code matching state

### 3. Add Device

There are 3 ways to add a device

Method 1. Enter the Tuya APP. The main page automatically pops up "Device to be added" (as picture 1) and click "Add".

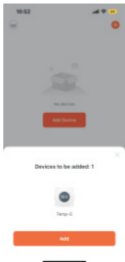

picture 1

Method 2: Enter the Tuya APP, Click "Add Device" or "+" (as picture 2) on the upper right corner of the APP homepage, and enter the "Add Device" interface. It will prompt: find the device to be added (as picture 3) and follow the prompts.



picture 2



picture 3

Method 3: Enter the Tuya APP, Click “+” on the upper right corner of the APP homepage, Find the temperature control product (Bluetooth + WIFI model) in the (small household appliance). (as picture 4)

As picture 5 ignore the content of the page and tap **Next**.

As picture 6 ignore the content of the page and click **Next**

As picture 7 tick confirm the indicator is blinking click **Next**



picture 4



picture 5

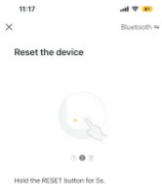

picture 6



picture 7

#### 4. Enter Wi-Fi information

Enter the name and password of the **2.4Ghz Wi-Fi** (please make sure that the Wi-Fi name and password contain only numbers and letters and not special symbols) Follow the prompts to the next step, you can see the device is being added, and after a few seconds, you will see that the device is added successfully (the length of time will depend on the strength of the wifi signal).

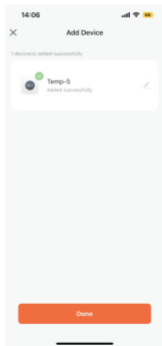
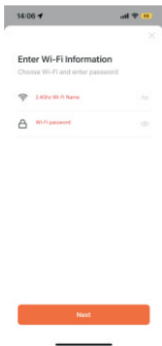

## 5. Display of temperature controller APP interface

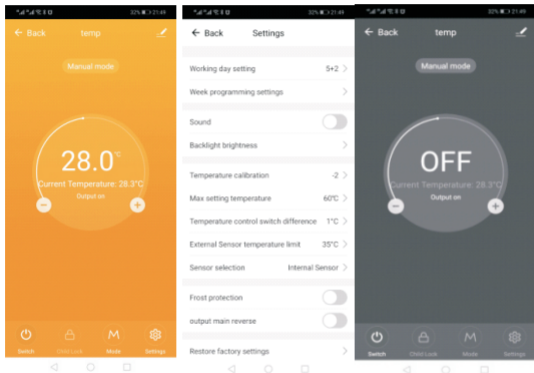

If you encounter any problems during the use of the product, please feel free to contact us through the purchase platform, we will try our best to help you.